

# SHELL Duo Colour Led Stripe Installation guide



**IMPORTANT:** Always work according to the Shell Life Saving Rules

**IMPORTANT:** Please make sure to read, understand and follow all the information and instructions in this guide. Failure to install dK-Led Duo Colour Led Stripe as described here will void any product warranty.



## ADDITIONAL NEEDED FOR INSTALLATION

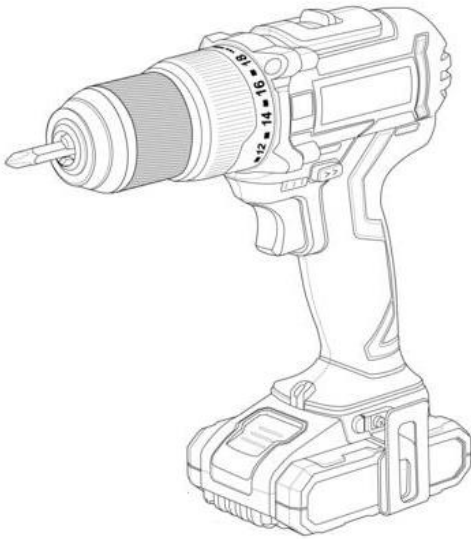

Cordless drill

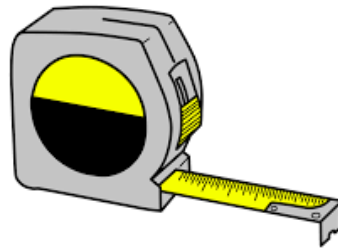

Tape measure

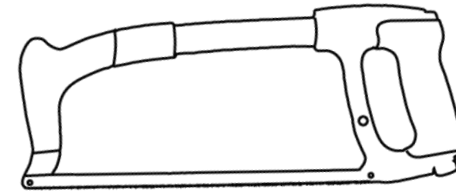

Saw

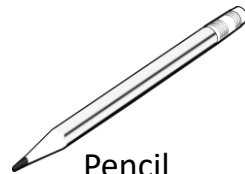

Pencil



Miter Box



Acrylic cement



Self drilling screws



Flashlight



3M UY2 connectors



Tape

### PRODUCT OVERVIEW

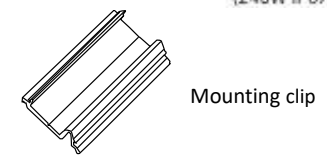
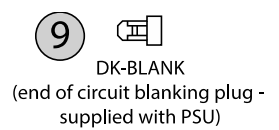
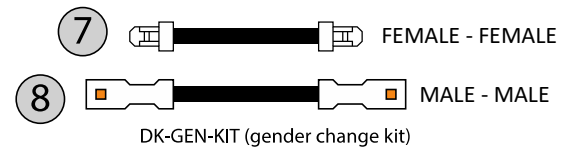
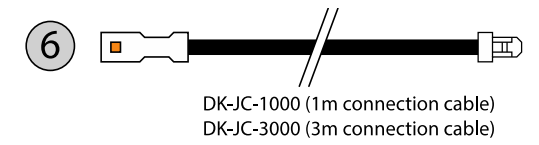
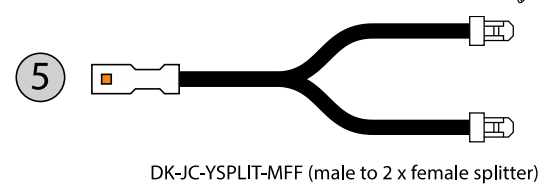
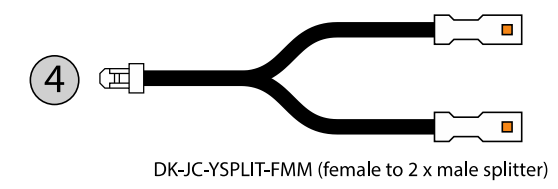
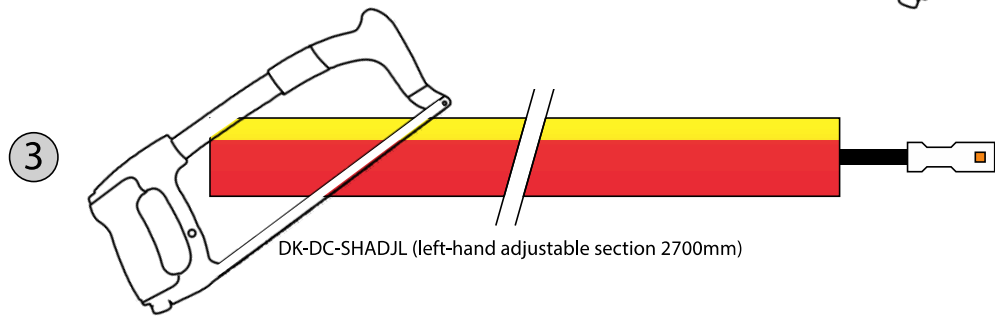
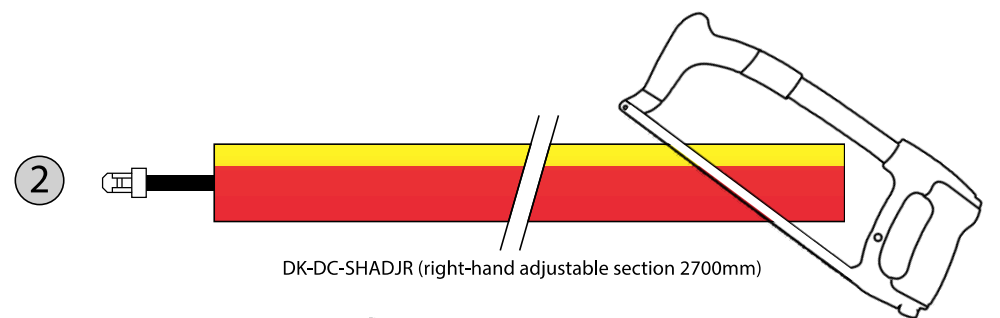
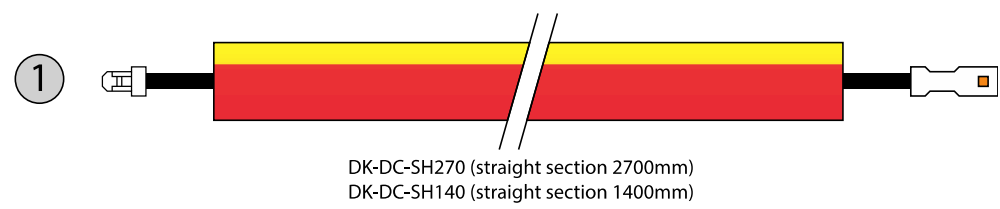

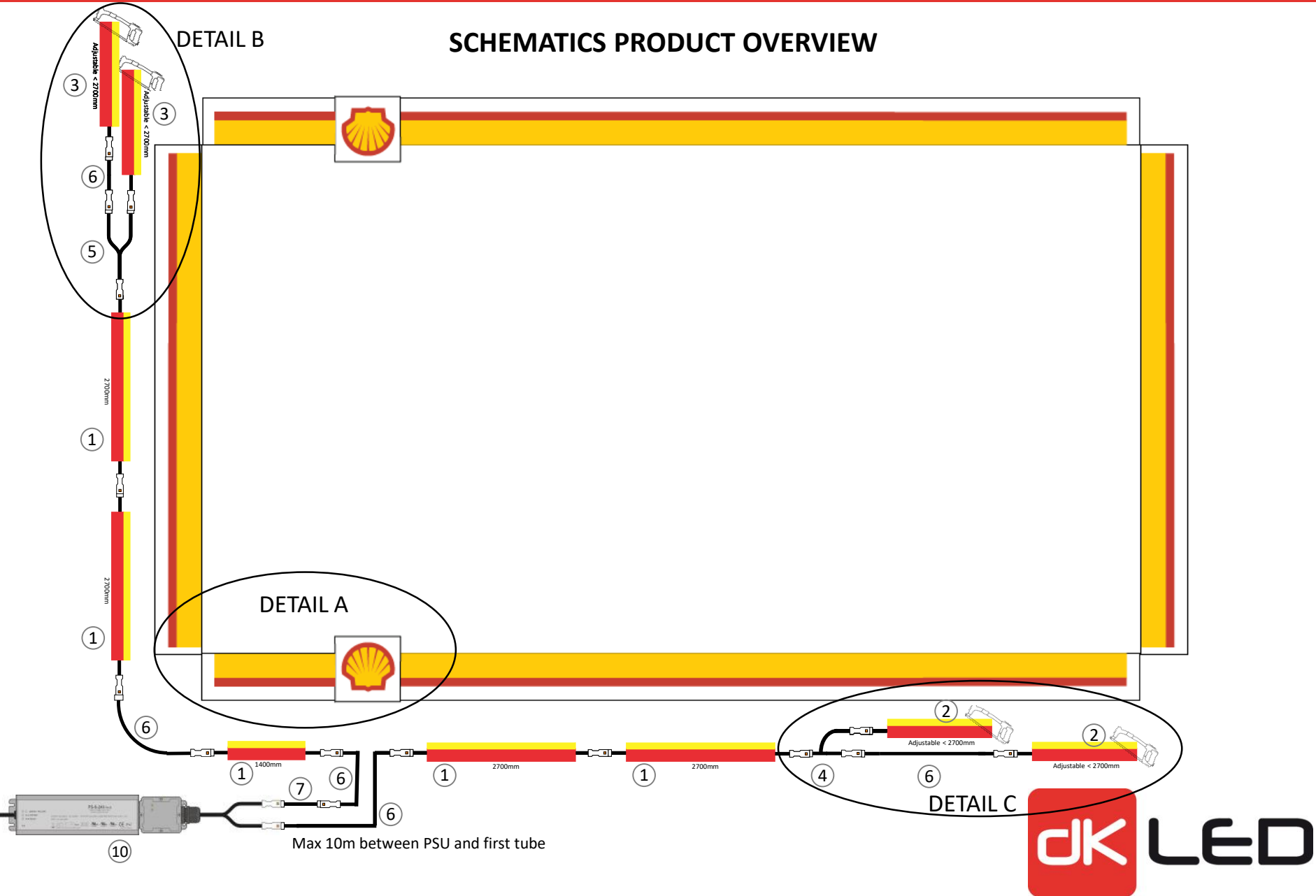

## DETAILED SCHEMATICS PRODUCT OVERVIEW

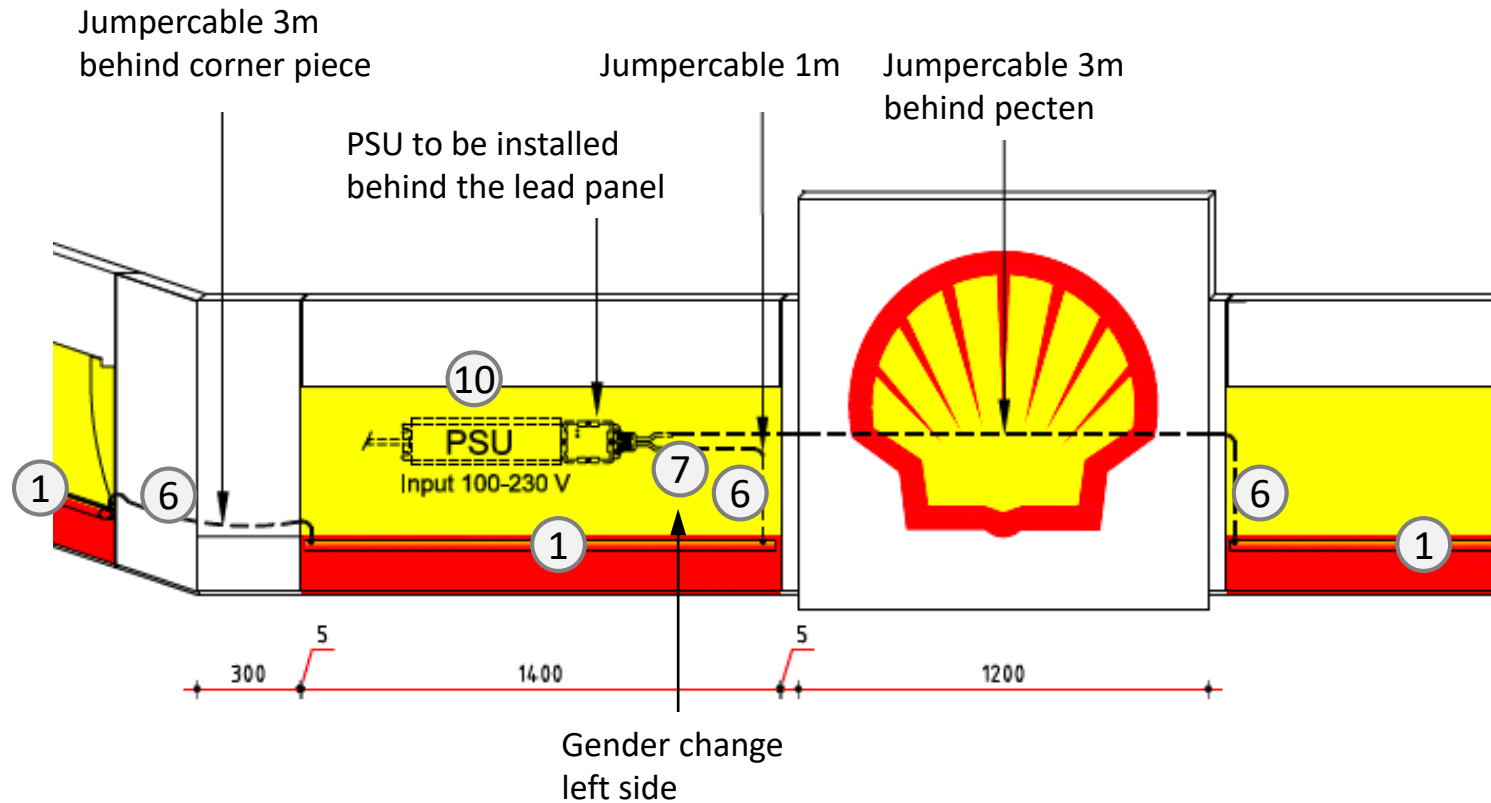

DETAIL A

### DETAILED SCHEMATICS PRODUCT OVERVIEW

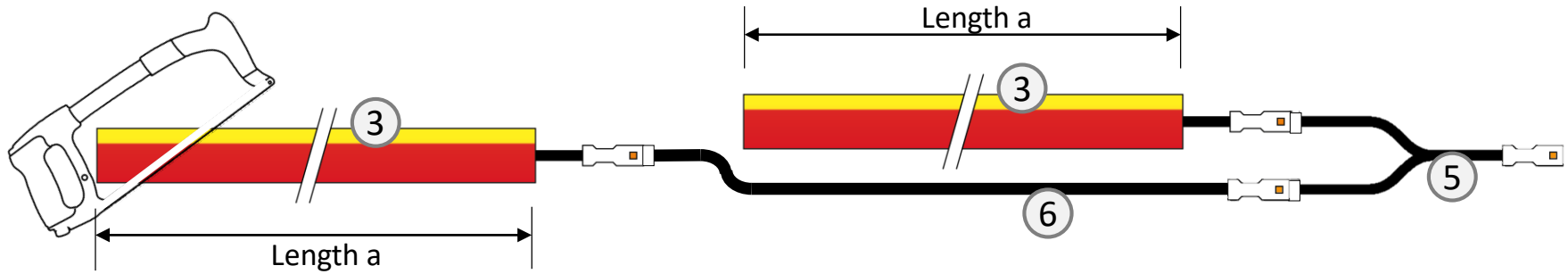

#### DETAIL B, left adjustables

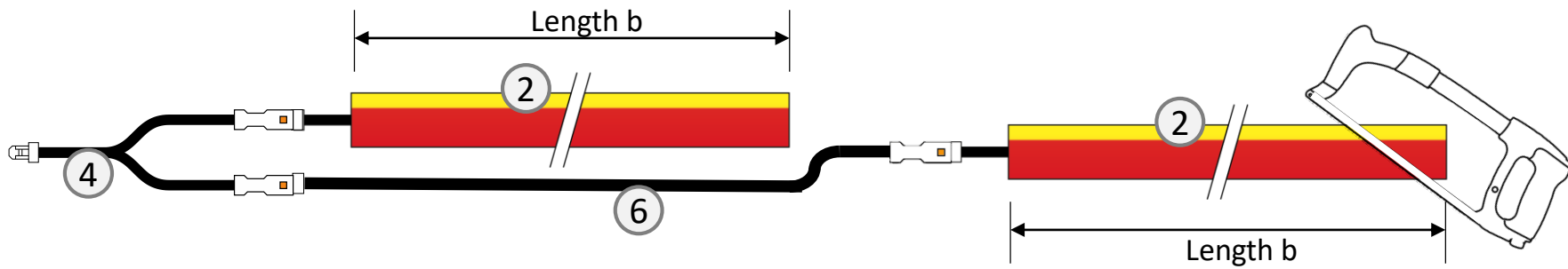

#### DETAIL C, right adjustables

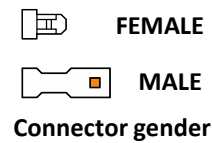

### INSTALLING THE LED STRIPE

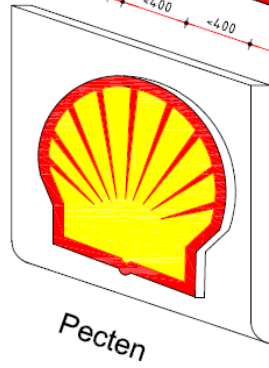
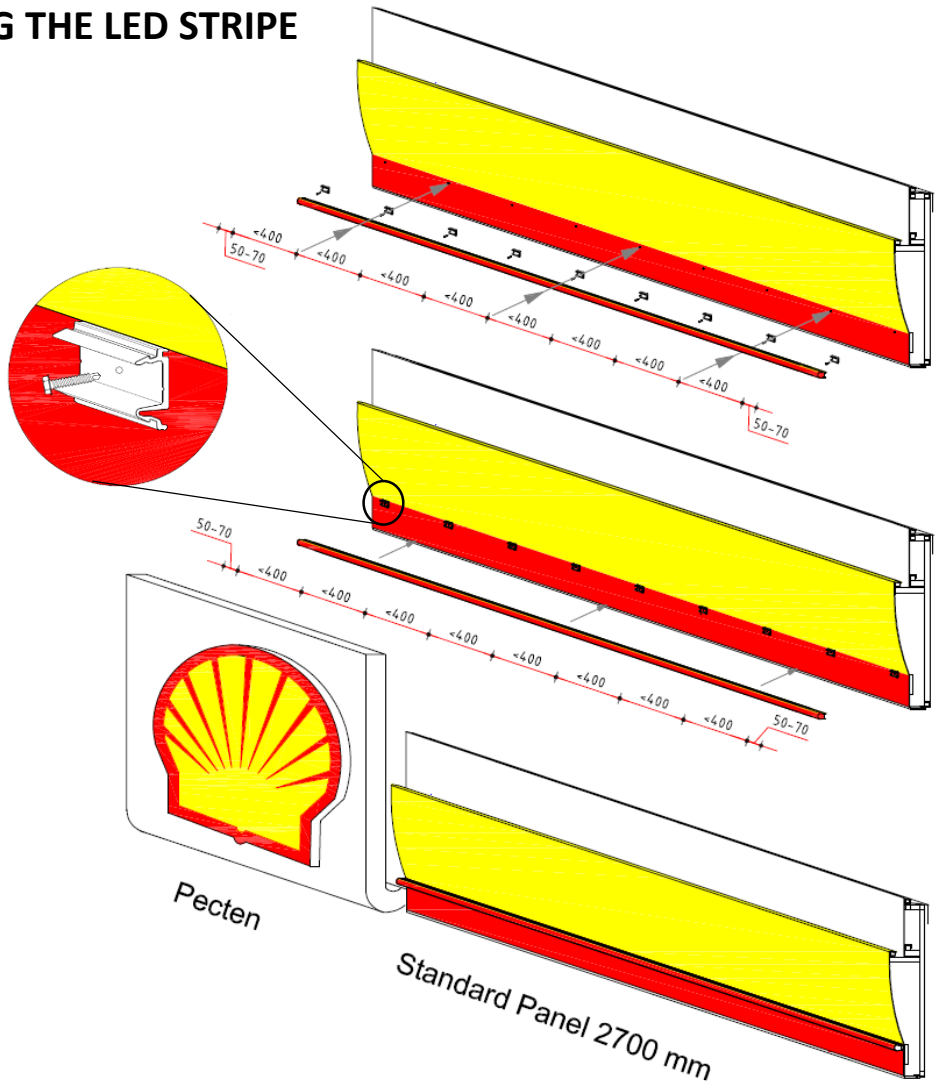
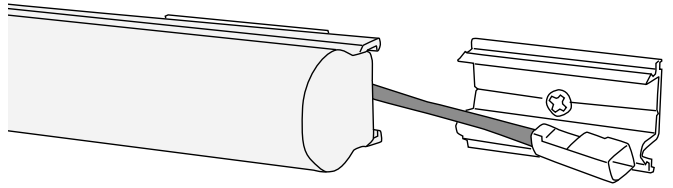
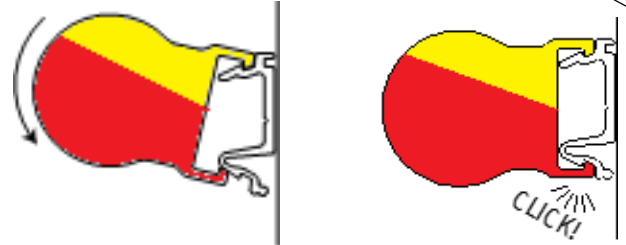
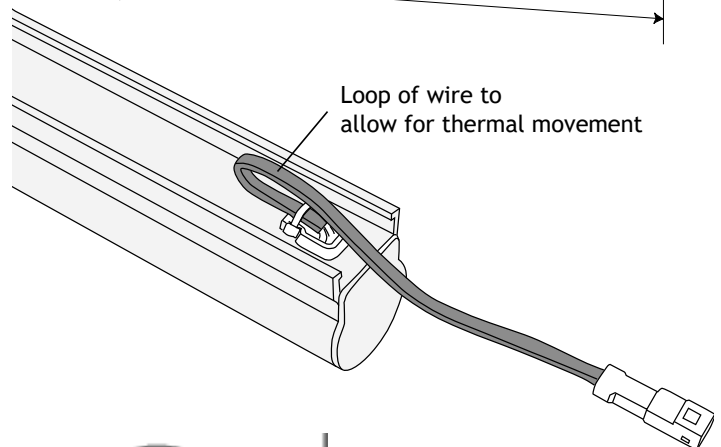
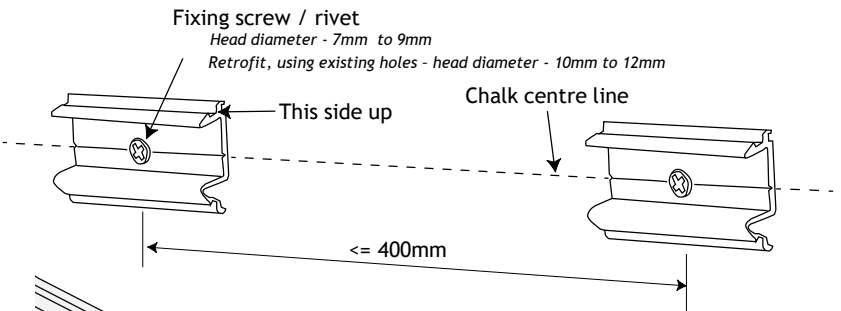

## INSTALLING THE LED STRIPE

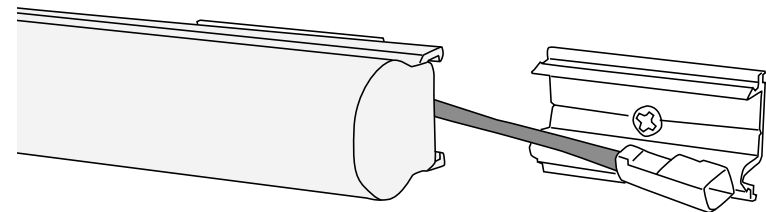
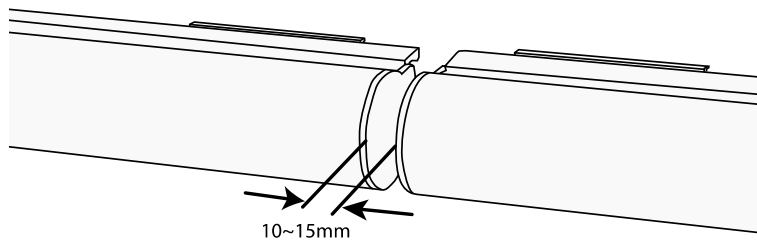
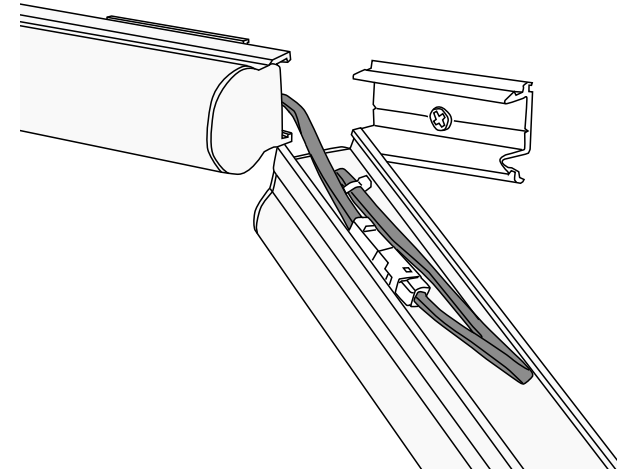
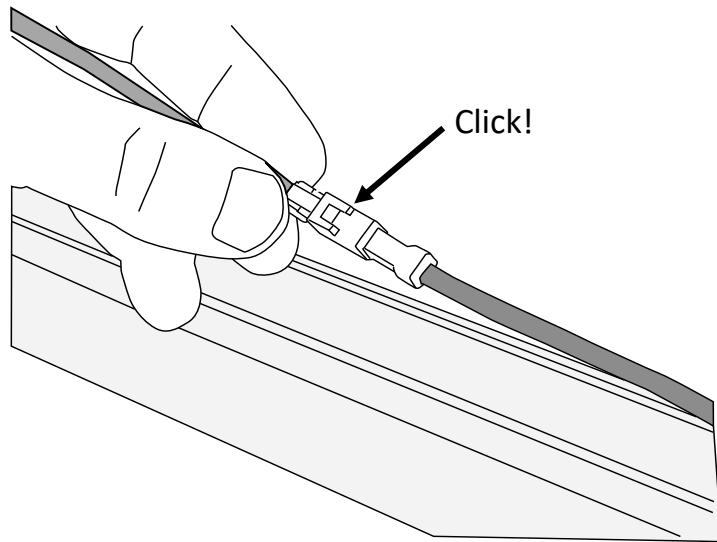



## SHORTEN THE ADJUSTABLE LED STRIPE



The adjustable Duo Colour Led Stripe can be cut at specific locations approximately every 50mm.

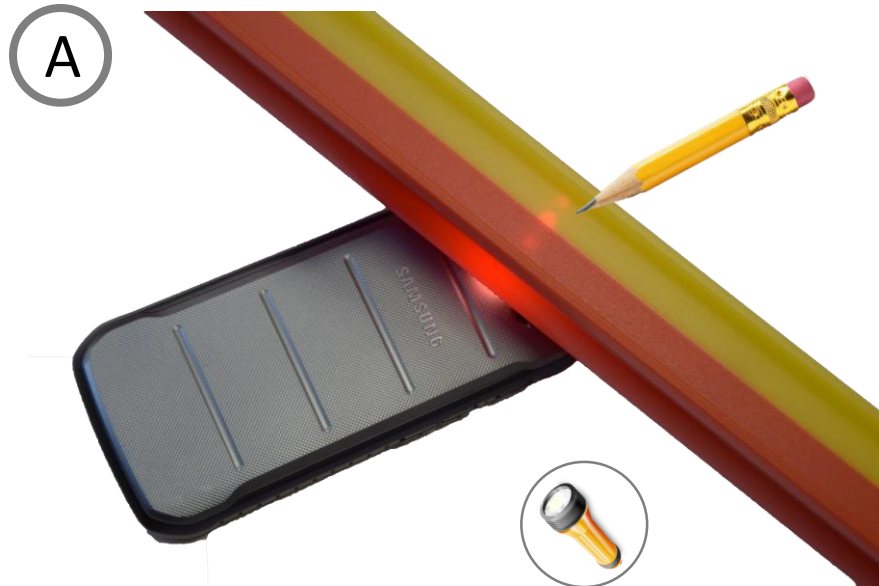

To locate a cut position shine a torch (or smart phone with torch function) from the face side. Cut positions will be seen as a row of three bright dots along the rear of the tube. Mark the required cut position.

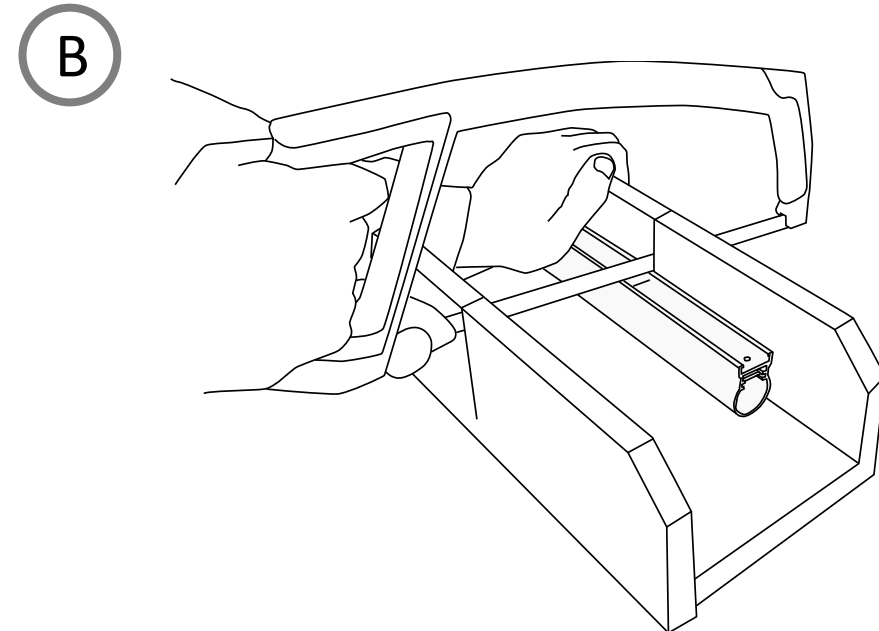

Field-adjustable sections must be cut from the connector end only. Cut through the adjustable section at your mark using a hacksaw fitted with a fine-toothed blade. Use a miter box to ensure a clean, square cut.



Check this youtube instruction video  
[https://youtu.be/K\\_8m\\_3xE9QQ](https://youtu.be/K_8m_3xE9QQ)

## SHORTEN THE ADJUSTABLE LED STRIPE



C

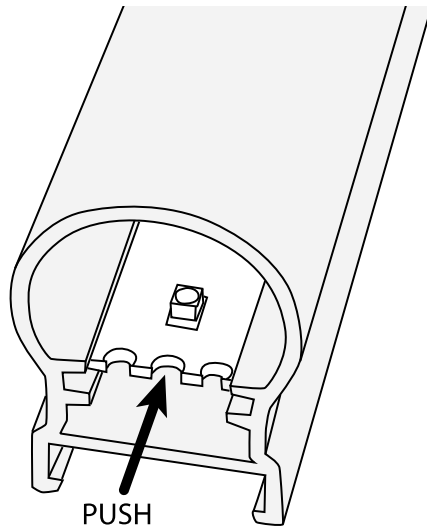

Remove any burrs and foreign material from the cut end. Ensure the cut is clean and square, sand if necessary. Before fitting the field end-cap, push the cut circuit board into the tube as far as it will go.

D

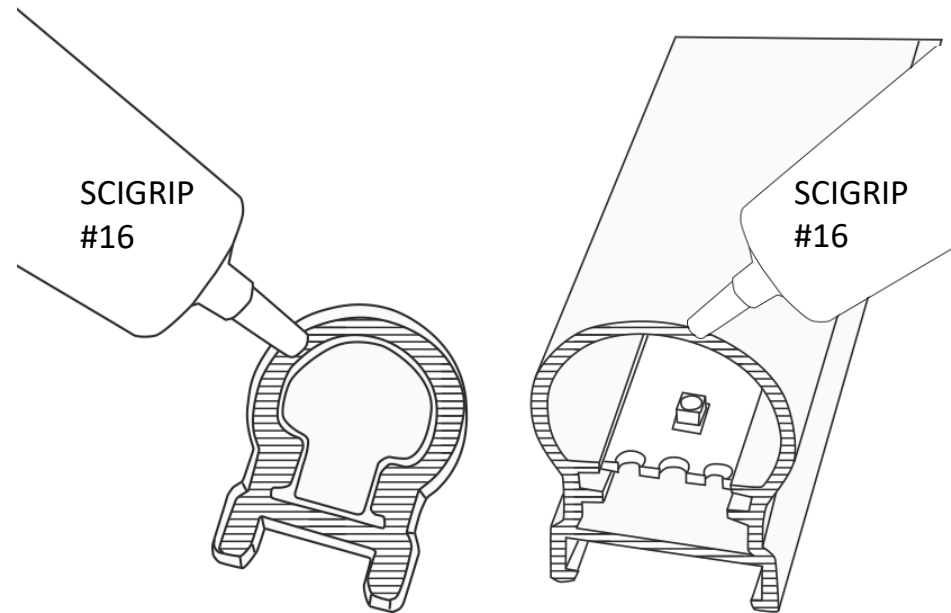

Apply a generous continuous bead of Weld-On 16 to both the end-cap and the cut end of the adjustable Led Stripe. Do not substitute any alternative adhesive or sealant.

**USE WELD-ON 16 ONLY IN A WELL VENTILATED AREA.  
BE SURE TO FOLLOW THE SAFETY INSTRUCTIONS ON THE  
TUBE**

## SHORTEN THE ADJUSTABLE LED STRIPE



E

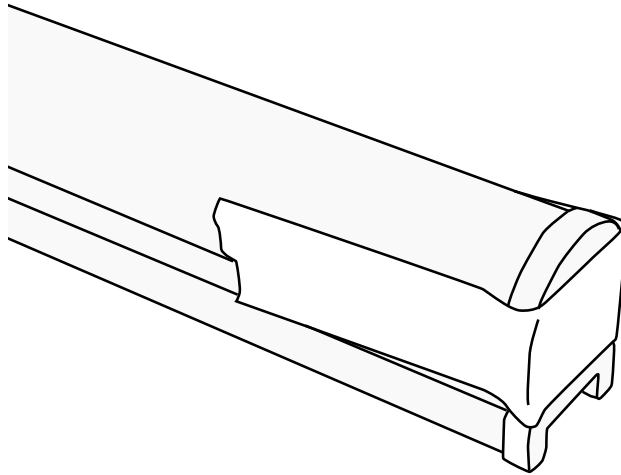

Use strong tape to top clamp the end-cap in position for at least 10 minutes before handling the tube further. Once the glue is dry, the adjusted tube section can be fitted.

F

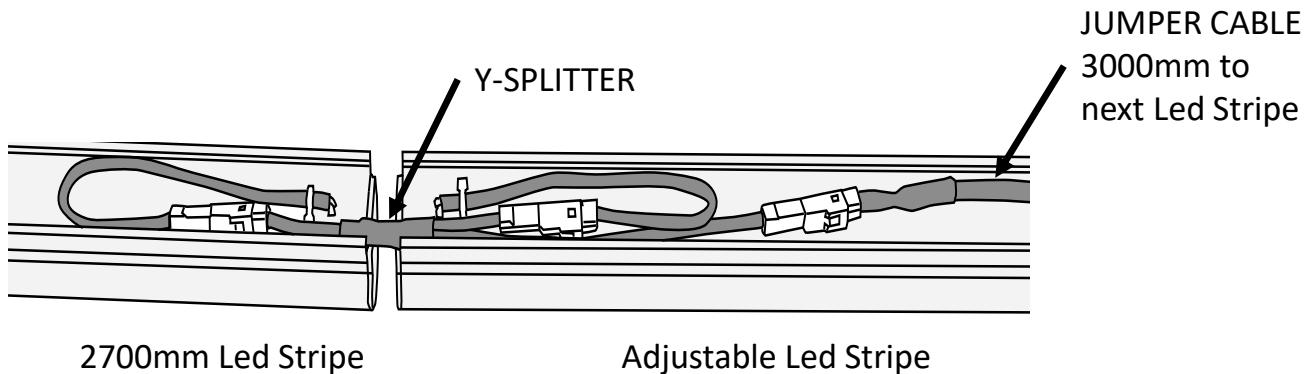

The adjustable Led Stripe has only one connector. To connect a following Led Stripe, use a Y-SPLITTER.

## SHORTEN THE ADJUSTABLE LED STRIPE



G

When the jumper cable is too long, it is allowed to shorten it using 3M Scotchlok UY2 connectors

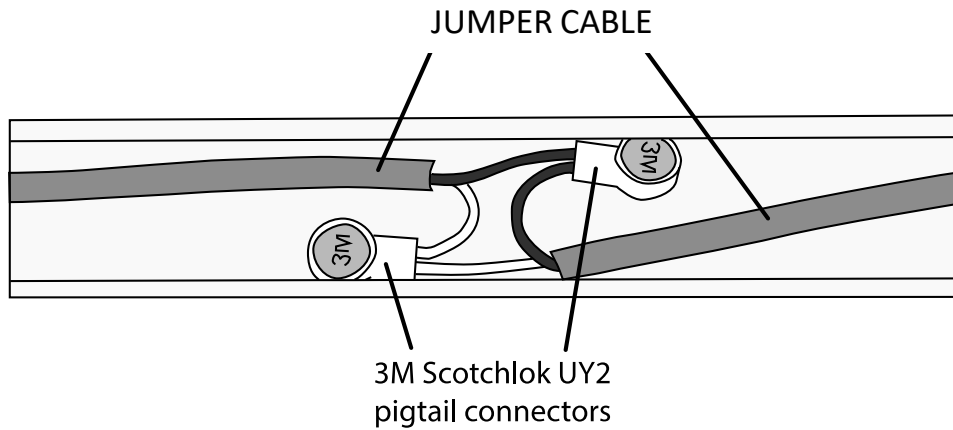

## PSU with Current Sense Circuit (CSC)

The current sense circuit (CSC) is an integral part of the PSU. Its function is to continuously monitor the installation and remove the low-voltage supply should a fault be detected. Whilst it is primarily a safety feature, it can also assist in troubleshooting.

The CSC has a status LED which indicates the current state of the circuit. There is an LED for each output channel.

### Operation

During normal operation the CSC continuously and automatically performs tests on the DC supply to the Led Stripe installation. Should a fault be detected the DC output is switched off. Once this has occurred, a series of attempts to reinstate the DC supply are made at intervals increasing from 1 second to 1 hour. Should any re-try be successful, the DC output is switched on and the CSC enters a back-off mode. In this back-off mode the re-try period that will be applied should a further fault be detected is slowly reduced back to 1 second.

Should the fault still be present after the full retry cycle of 5 hours, the CSC enters an abort mode. Once in this mode, no further retries are made and the status LED flashes red.

When a fault is detected, the status LED pulses a number of times rates to indicate the type of fault. The table below lists these faults.

Pulse ratio	Fault indicated
2 pulses	Start-up impedance test failure
3 pulses	Current monitor failure
4 pulses	Run-time impedance test failure
5 pulses	reserved
6 pulses	Run-time voltage test failure
7 pulses	Start-up voltage test failure
8 pulses	Over-current

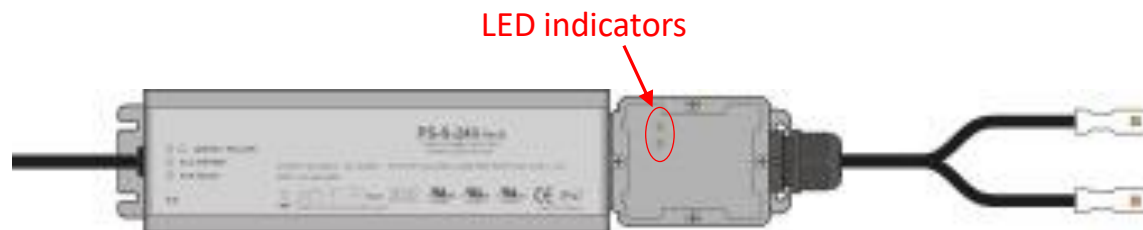

## PSU with Current Sense Circuit (CSC)

Possible causes for each fault type are;

### ***2 pulses - Start-up impedance test failure***

The system has detected a low resistance across the output before it has applied power. This can be caused by a faulty or damaged tube section, badly made connections between sections or water inside the connectors.

### ***3 pulses - Current monitoring failure***

The system has detected fluctuations in current in the installation. This is usually caused by a faulty or damaged tube section or a badly made connection between sections.

### ***4 pulses – Run-time impedance test failure.***

Similar to 2 pulses above but this test is carried out at 10 second intervals during normal operation.

### ***6 pulses - Run-time Voltage test failure.***

This test is carried out at 10 second intervals during normal operation, and a failure indicates either a faulty or damaged tube section, usually with water ingress, or that the connectors contain trapped water.

### ***7 pulses - Start-up voltage test failure.***

Similar to 6 pulses above but this test is carried out at start-up, before power is applied.

### ***8 pulses –Over-current failure.***

The load exceeds the maximum allowed. Reduce the load on the output channel.

## Blanking Plug on empty connectors

Always install a Blanking Plug on any empty connectors to avoid open end on cabling.  
This can occur when no Adjustable is needed.

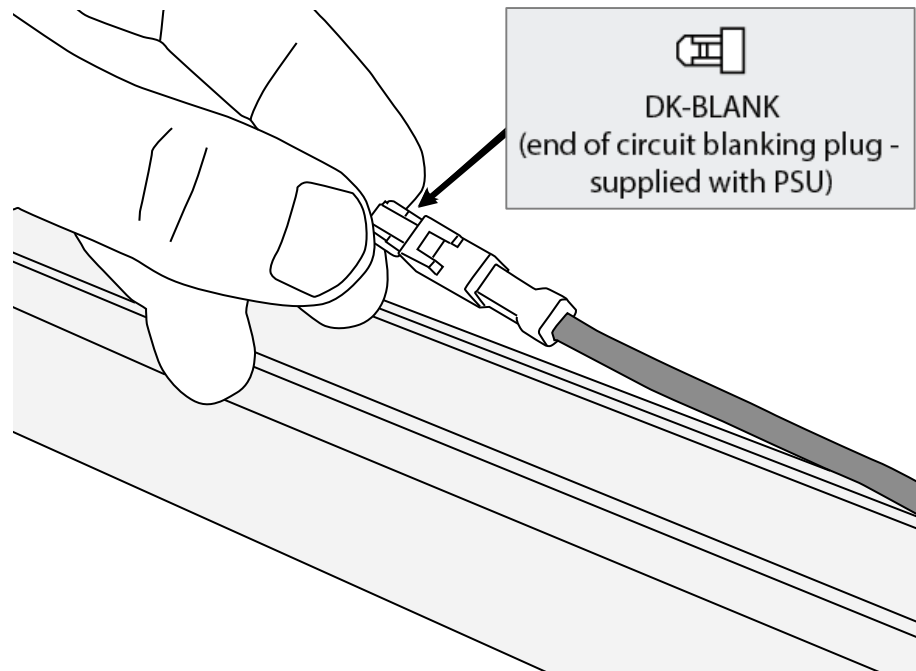

<b>Duo Colour Led Stripe</b>	
Diameter:	30mm
Height:	45mm
Standard length:	1400mm - 2700mm
	Left hand and right hand adjustable
Material housing:	Extruded PMMA
LED brand:	Samsung
LED colour:	White 4000K
No. of LEDs used:	58 per m
Nominal power consumption:	4.8W per m
Expected lifetime (70% brightness):	100.000 (h)
IP rating LED tube:	IP66
Max length on 240W PSU:	24m per output
<b>Power Supply</b>	
Output Voltage:	46V DC - SELV
Input mains Voltage:	90V to 264VAC
IP rating driver:	IP67
Marking:	CE - CCC - C UR US
Safety:	Current Sense Circuit
<b>Environmental</b>	
Operating temperature:	-30°C to +50°C
Tested temperature (24h):	-40°C to +60°C
Humidity:	30% to 95%



## Do's and Don'ts

Don't hold the Led Stripe only by its cable



Always hold the Led Stripe by its tube

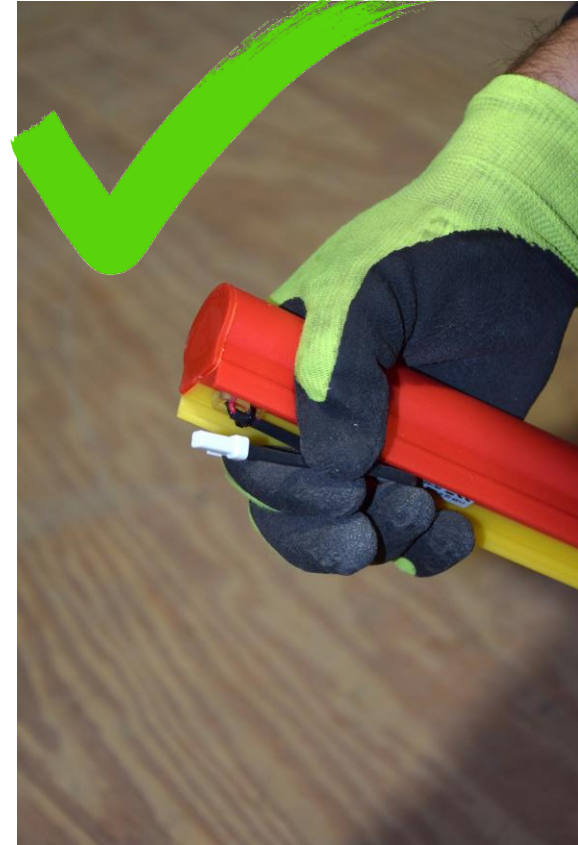

## Do's and Don'ts



Never install damaged materials, always check before installation.

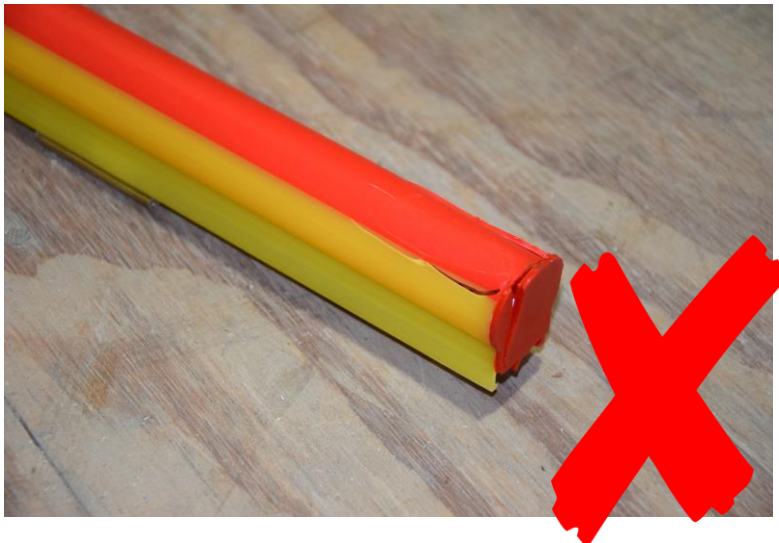

## Do's and Don'ts



Never try to repair damaged materials,  
always install undamaged Duo Colour Led  
Stripe

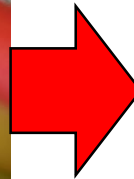



Existing hole previous Red Bar bracket

1

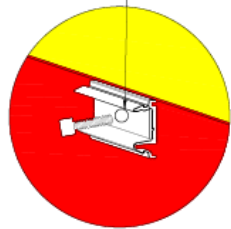

D1

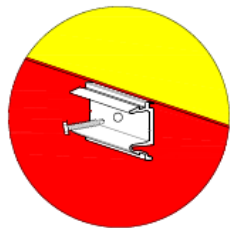

D2

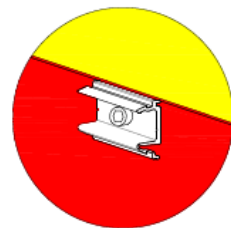

D3

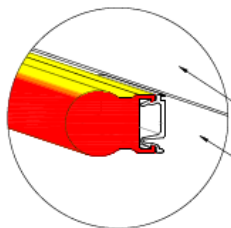

D4

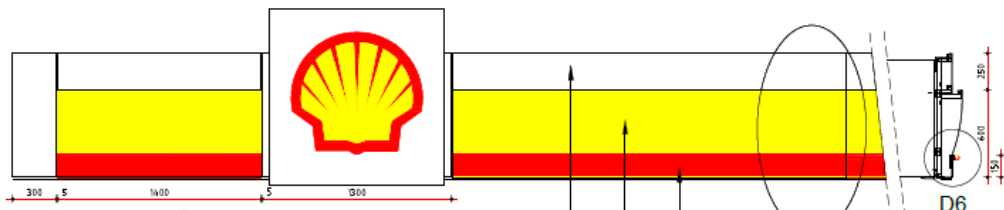

2

Existing holes former Red Bar bracket

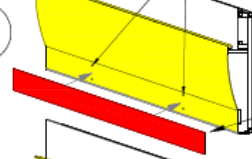

3

Added ACM Shell Red

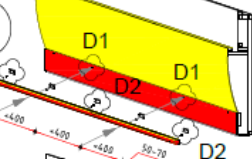

4

Existing holes former Red Bar bracket

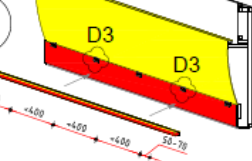

5

Lead Panel 1400 mm

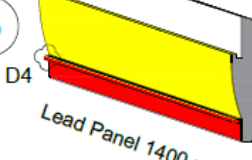

Pecten

Standard Panel 2700 mm

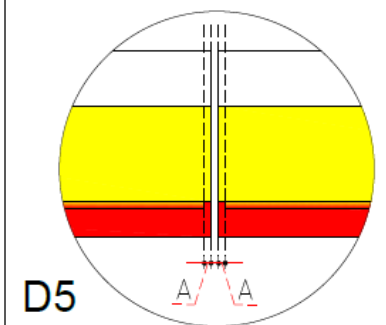

D5

Center the tube on the panel. Between two tubes there needs to be space for expansion.



If hammer head bolt applies

D6

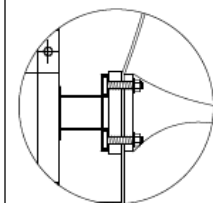

Current situation

New situation

- All dimensions on drawing are in mm
- Construction according to specification constructor
- Check dimensions in work

**dk LED** Ekkersrijt 1200  
5802 AG Son en Breugel  
The Netherlands  
Tel. +31(0)499 - 478 777  
www.dkled.nl  
info@dkled.nl

Te opzet: 14-08-2017	Wijziging C:
Wijziging A: 14-12-2017	Wijziging D:
Wijziging B:	Wijziging E:
Project: Installation manual red bar replacement by Duo Colour Led Stripe	Fase: Sketch design
	Format: A3
	Scale: 1:30 / 1:5 / 1:2
Description: Canopy fascia RVLe	Proj.nr:
Section: Replacement	Pagennr: 1. 02

The Shell Duo Colour tube is a patent pending product of De Kaver Installaties B.V. registered under id-number 2018788. This drawing is property of De Kaver Installaties B.V. located in Son en Breugel, The Netherlands and may NOT be reproduced, multiplied or shown/shared to third parties without our WRITTEN permission. Copyright ©

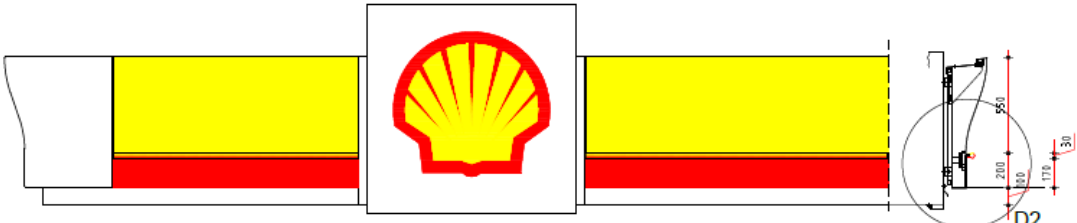
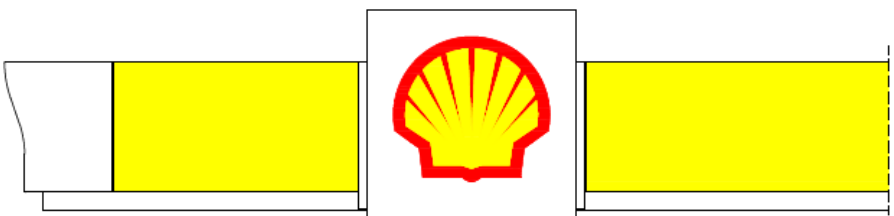

If hammer head bolt applies

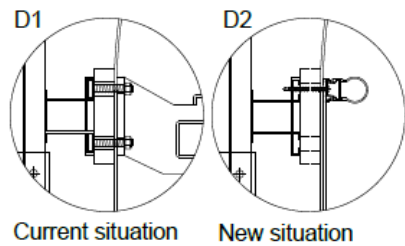

- All dimensions on drawing are in mm
- Construction according to specification constructor
- Check dimensions in work

		Ekkersrijf 1209 5692 AG Son en Breugel The Netherlands Tel. +31(0)499 - 476 777 www.dkled.nl info@dkled.nl	
		Te opzet: 28-08-2017 Wijziging A: 14-12-2017 Wijziging B:	Wijziging C: Wijziging D: Wijziging E:
Project: Installation manual red bar replacement by Duo Colour Led Stripe		Fase: Sketch design Format: A3 Scale: 1:25 / 1:5	Proj.nr: Pagernr: I. 03.1
Description: Canopy fascia RV1 one		Section: Replacement	

The Shell Duo Colour tube is a patent pending product of De Kaver Installaties B.V. registered under number 2018788. This drawing is property of De Kaver Installaties B.V. located in Son en Breugel, The Netherlands and may NOT be reproduced, multiplied or shown/loaned to third parties without our WRITTEN permission. Copyright ©

# SHELL Duo Colour Led Stripe Retrofit Old Red Bar RV11

date: 13-07-2018

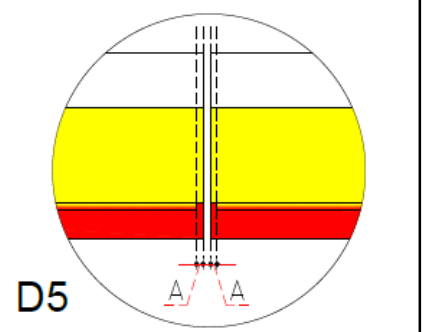
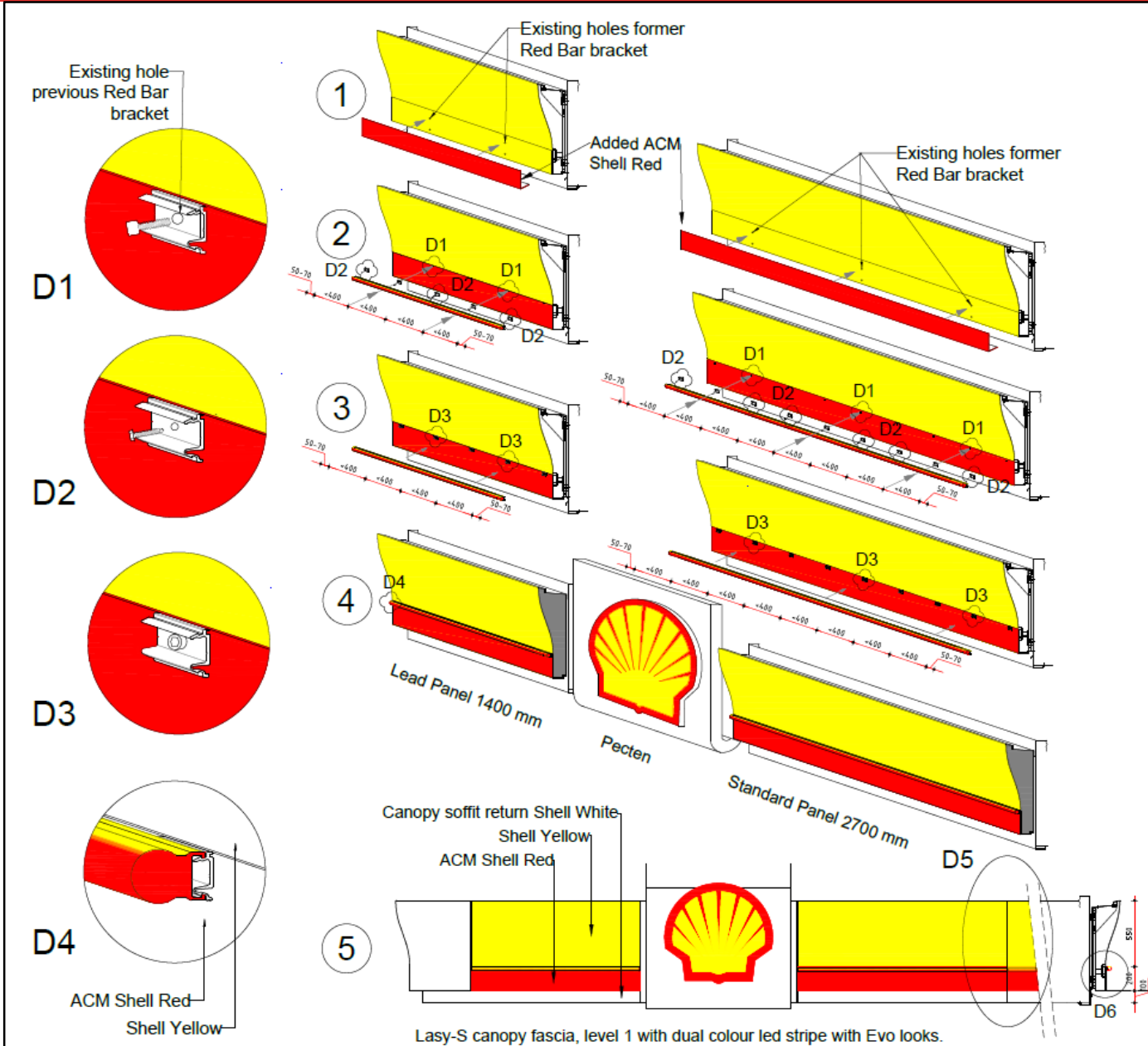

Center the tube on the panel. Between two tubes there needs to be space for expansion.



If hammer head bolt applies

Current situation      New situation

- All dimensions on drawing are in mm
- Construction according to specification constructor
- Check dimensions in work

<b>dk LED</b>	Ekkensrijf 1209 5692 AG Son en Breugel The Netherlands Tel. +31(0)499 - 476 777 www.dkled.nl info@dkled.nl
Tie opzet: 21-08-2017 Wijziging A: 28-08-2017 Wijziging B: 14-12-2017	Wijziging C: Wijziging D: Wijziging E:
Project: Installation manual red bar replacement by Duo Colour Led Stripe	Phase: Sketch design Format: A3 Scale: 1:30 / 1:5 / 1:2
Description: Canopy fascia RV1 one	Proj.nr.:
Section: Replacement	Pagern: 1.03.2

The Shell Duo Colour tube is a patent pending product of De Kaver Installaties B.V. registered under license number 2018788. This drawing is property of De Kaver Installaties B.V. located in Son en Breugel, The Netherlands and may NOT be reproduced, multiplied or shown/related to third parties without our WRITTEN permission. Copyright ©

Easy-S canopy fascia, level 1 with dual colour led stripe with Evo looks.

